

PLM Series Precision Leveling Mount

Operating/Installation Instructions

Safety notices

Please carefully read through these instructions before installing and commissioning the air spring system and keep them for future reference.

If any questions arise at this point or if clarification is required, do not commission the air spring system and instead first contact ACE Stoßdämpfer GmbH.

T +49 (0)2173-9226-20

Failure to comply with this instruction manual can cause the PLMs to burst and lead to injury (risk of crushing).

Applicable national legislation has priority over these instructions.

If the equipment is installed by the customer, ACE shall not be held liable for any installation and assembly mistakes and the damage that could result.



Explanation of icons



Safety and maintenance information



Attention: Risk of crushing!



Attention: Risk of bursting!

IMPORTANT NOTES:



- Do not inflate PLM isolation mounts unless static weight of equipment is placed on the mounts
- Do not use PLM isolation mounts under static loads greater than the indicated maximum (see Chart B).
- Do not pressurize PLM isolation mounts above indicated maximum pressure. Check pressure with pressure gauge. (See Chart B)
- Completely deflate isolation mounts before moving or relocating equipment.
- Support base of machine should be level and horizontal.

INTENDED PURPOSE:

The properly use of the PLMs is the vibration isolation from microscopes, optical equipment, and similar equipment.

The PLM isolation mounts are **not** usable as dynamic dampers!



INSTALLATION:

1. Support base of machine should be level within $\pm 1\text{mm}$ ($\pm 1/32''$) before inflating isolation mounts.

Impermissible

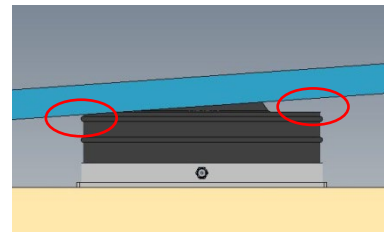
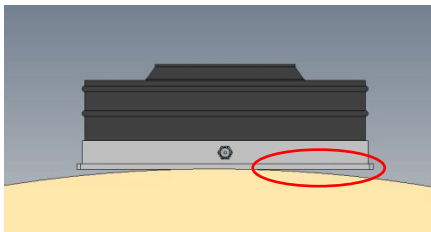

Permissible

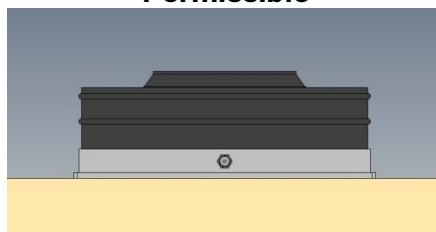

2. Place PLM isolation mounts underneath equipment to be isolated and secure equipment using threaded center hole in PLM top center plate.
3. Isolated equipment foot should cover the entire surface of the mount. If not, a plate of a minimum diameter "D" should be placed between the foot and the mount. (Chart A)

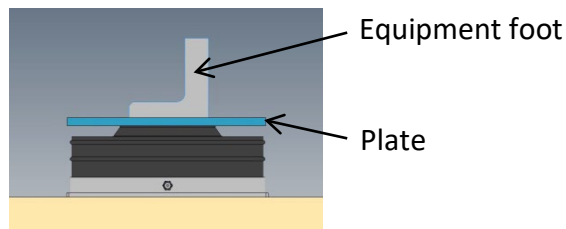

4. If fastening isolation mount to its support, install bolts or screws through holes provided in mount base plate. Tighten all bolts/screws to usual fastening torque.

5. If the isolation mount has a Schrader valve, the air will flow in and out the PLM by pushing the valve.
6. Sequentially pressurize each mount through valve until dimension "X" is 1,6mm (1/16") (see drawing on page 5).
7. Continue sequential pressurization of each mount so that dimension "X" increases in increments of approximately 3mm (1/8") until "X" is between 12mm -14mm (1/2" - 9/16").

LEVELING:

1. Inflate or deflate with air to raise or lower the height of each isolation mount until desired level within the working height tolerance is reached.
 Levelling range PLM1 and PLM3 : $\pm 3\text{mm}$ ($\pm 1/8''$)
 Levelling range PLM6-PLM192: $\pm 6\text{mm}$ ($\pm 1/4''$)
2. If the PLM mounts are connected to a system, the adjusting is done by the pressure regulator.
3. PLM mounts with a Schrader valve have to get pressurized depressurized by pushing the valve .
4. Check each mount for overall height indicated in the Chart B. If exceeding this range, repeat inflating/deflating process until minimal height incl. tolerances and desired level is reached. Tolerance $\pm 3\text{mm}$ ($\pm 1/8''$).

Do not exceed the levelling range

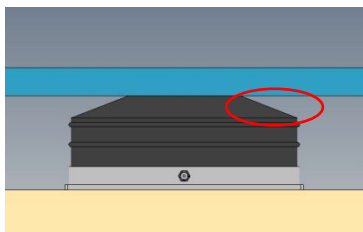

Do not fall below the levelling range

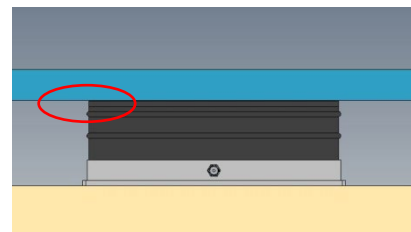

Perfect working condition

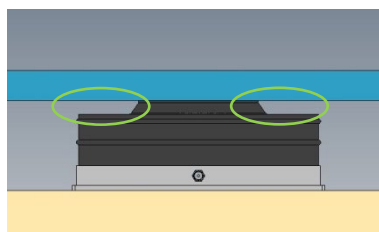

UNINSTALLATION

1. Completely remove air from all isolation mounts.
2. Move, relocate, or change static weight.

MAINTENANCE & DISPOSAL:

The PLM isolation mounts are maintenance-free.
The pressure must get controlled occasionally.

We recommend a moist cloth with neutral PH cleaner for cleaning the PLM.
No sand-, chloride- or acidic cleaner and solvents.



The PLM isolation mounts are free of hazardous substances.
If you want to dispose this product, please contact your local responsible municipal administration for environment friendly recycling.

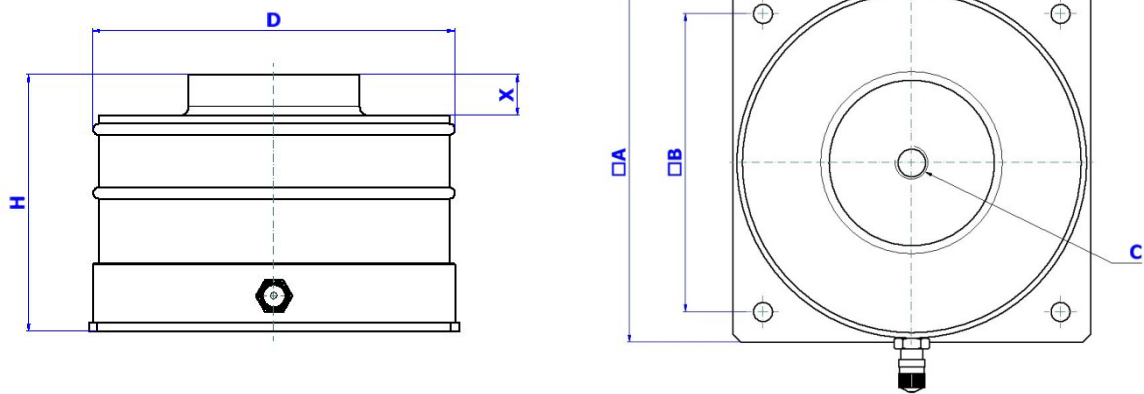

Dimensions in mm

Chart A	□A in mm	□B in mm	C Metric Selectable	C Inch Selectable	∅D in mm	H in mm (Working Height)	Adjustment range in mm
PLM1	76,2	60,3	M10	3/8-16	74	62,5	±3
PLM3	106,4	88,9	M12	1/2-13	106	63,5	±3
PLM6	130,2	108	M12	1/2-13	127	89	±6
PLM12	174,7	152,5	M12	1/2-13	171	89	±6
PLM24	254	216	M16	5/8-11	246	89	±6
PLM48	343	304,9	M16	5/8-11	339,8	89	±6
PLM96	470	406	M24	1-14	468	89	±6
PLM192	610	508	M24	1-14	604	89	±6

Dimensions in inch

Chart A	□A in inch	□B in inch	C Metric Selectable	C Inch Selectable	∅D in inch	H in inch (Working Height)	Adjustment range in inch
PLM1	3	2.375	M10	3/8-16	2.91	2.46	±0.12
PLM3	4.188	3.5	M12	1/2-13	4.17	2.5	±0.12
PLM6	5.125	4.25	M12	1/2-13	5	3.5	±0.23
PLM12	6.875	6	M12	1/2-13	6.73	3.5	±0.23
PLM24	10	8.5	M16	5/8-11	9.68	3.5	±0.23
PLM48	13.5	12	M16	5/8-11	13.37	3.5	±0.23
PLM96	18.5	16	M24	1-14	18.41	3.5	±0.23
PLM192	24	20	M24	1-14	23.77	3.5	±0.23



A STABILUS COMPANY

WHEN PERFORMANCE MATTERS

Operating information

Chart B	Max. load		Max. Pressure	
	Kg	lbs.	Bar	psi
PLM1	45	99	6	87
PLM3	150	330	6	87
PLM6	250	551	6	87
PLM12	550	1,212	6	87
PLM24	1.100	2,425	6	87
PLM48	2.200	4,850	6	87
PLM96	4.400	9,700	6	87
PLM192	8.800	19,400	6	87

ACE Stoßdämpfer GmbH

Albert-Einstein-Straße 15
40764 Langenfeld
Germany

T +49(0)2173-9226-20

info@ace-int.eu
www.ace-ace.de